

Gemini 18 – sistem za klizna vrata

- Klizna vrata sa dvostrukom vodilicom za ispunu 18mm
- Težina vrata do 50kg
- Donji podesivi kotači
- Gornji gumirani kotači sa kugličnim ležajem za nečujno vođenje i dugotrajnost
- Ručke dužine 2,7 m
- Vodilice od 3 m, 4 m ili 6 m

 **SEVROLL**®

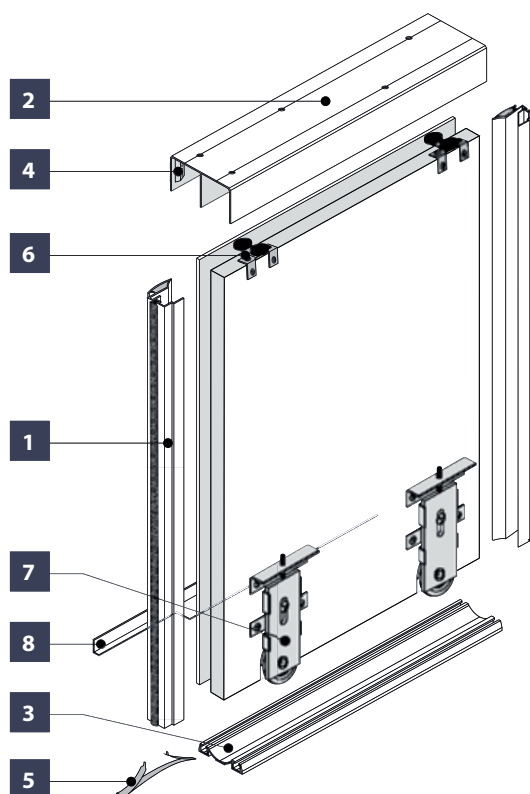

Gemini 18 – sistem za klizna vrata

1 Profilne ručke ALFA, FAWORYT i ROMA

1a Ručka ALFA

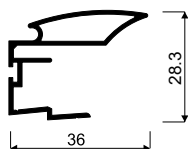
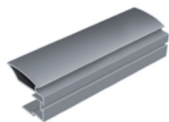

Ident	Naziv	MJ
SVGRALFA	Sevroll G18 ručka ALFA 2,7m ALU	KOM

1b Ručka FAWORYT

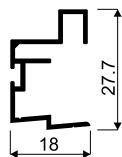

Ident	Naziv	MJ
SVGRFAWORYT	Sevroll G18 ručka FAWORYT 2,7m ALU	KOM

1c Ručka ROMA

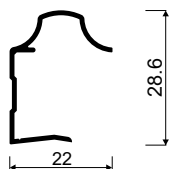
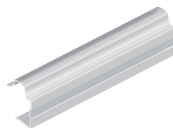

Ident	Naziv	MJ
SVGRROMA	Sevroll G18 ručka ROMA 2,7m ALU	KOM

1d Ručka TYTAN

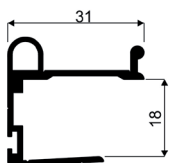

Ident	Naziv	MJ
SVGRTYTAN	Sevroll G18 ručka TYTAN 2,7m ALU	KOM

2 Vodilica gornja Gemini

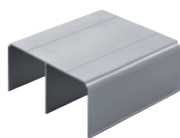

Ident	Naziv	MJ
SVGGV3	Sevroll G18-4 vodilica gornja 3m ALU	KOM
SVGGV4	Sevroll G18-4 vodilica gornja 4m ALU	KOM
SVGGV6	Sevroll G18-4 vodilica gornja 6m ALU	KOM

3 Vodilica donja Gemini

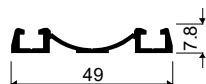

Ident	Naziv	MJ
SVGDV3	Sevroll G18-4 vodilica donja 3m ALU	KOM
SVGDV4	Sevroll G18-4 vodilica donja 4m ALU	KOM
SVGDV6	Sevroll G18-4 vodilica donja 6m ALU	KOM

4 Gornji kotači Gemini

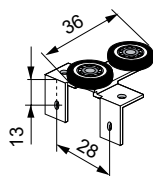

Ident	Naziv	MJ
SVGKG	Sevroll G18 set gornjih kotača	SET

5 Donji kotači Gemini 18 sa stoperom



Ident	Naziv	MJ
SVGKD	Sevroll G18 set donjih kotača sa stoperom	SET

6 L-profil 17x11

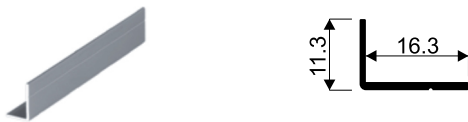

Ident	Naziv	MJ
SVGLPM18	Sevroll G18 L PROFIL MINI 3000 ALU	KOM

7 H-profil H18

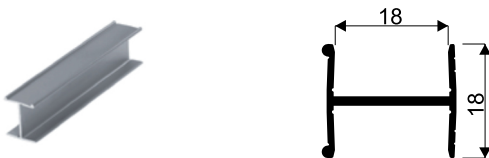

Ident	Naziv	MJ
SVGHP18	Sevroll G18 H profil 3000 ALU	KOM

8 Soft-close set



Ident	Naziv	MJ
SVGUB	Soft-close set (2 kom.) 40 kg	KOM

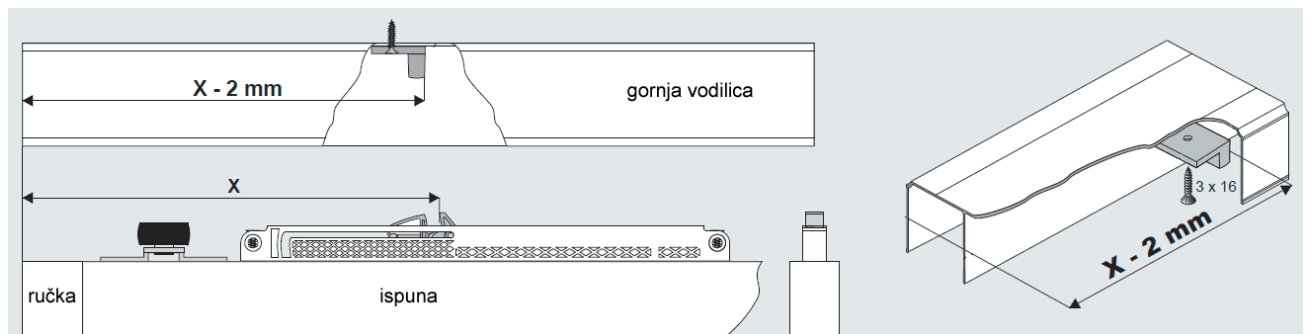

9 Brtvena četkice za bočnu stranu vrata

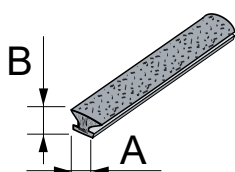

Ident	Naziv	MJ
SVGBČU1	Sevroll G18 brtvena četkica samolj. ROMA	TM
SVGBČU2	Sevroll G18 brtvena četkica uvlačna ALFA-FAWORTY	TM

Instrukcije za montažu

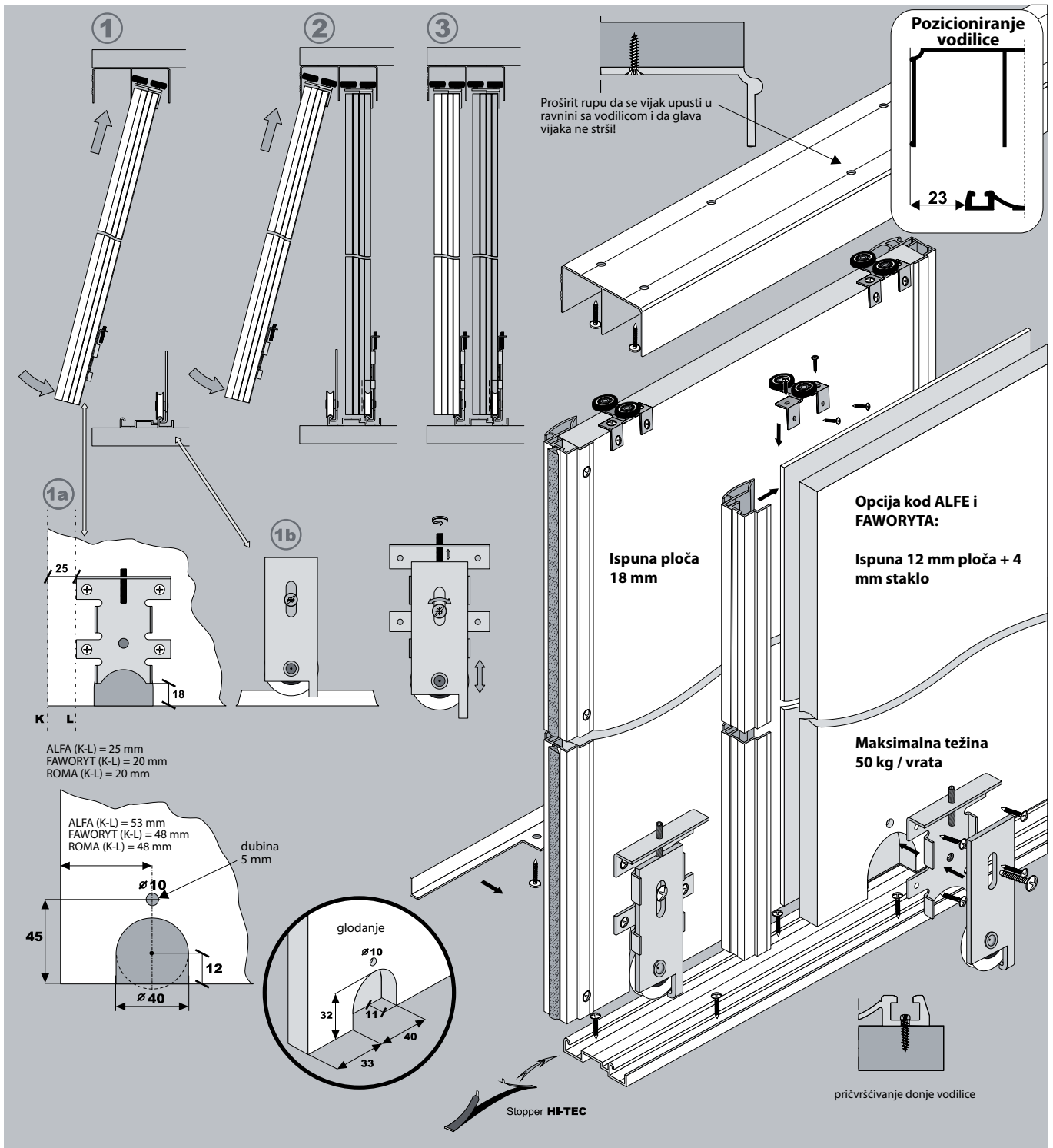

Ručka ALFA – ugradnja i mjere

Dimenzije otvora

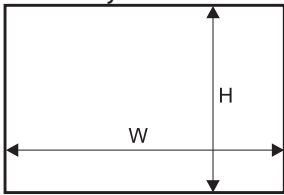

VISINA RUČKE = VISINA VRATA

visina vrata	- h	$h = H - 42 \text{ mm}$
visina vrata sa soft-close mehanizmom		$h = H - 42 \text{ mm}$
visina ploče	- hb	$hb = h - 2 \text{ mm}$
širina vrata	- w	$w = (W - 3 + Z) : N$
širina ploče 18 mm	- wb	$wb = w - 22 \text{ mm}$
širina ploče 12 mm	- wb_m	$wb_m = w - 7 \text{ mm}$
dužina L profila	- la	dužina L profila se određuje nakon konstrukcije vrata

broj vrata	- N	2	3	4	5
preklapanje	- Z	36 mm	72 mm	108 mm	144 mm

primjer - 4 vrata s 2 različita rasporeda	
	$w = (W - 3 + 108) : 4$
	$w = (W - 2 + 33) : 2$

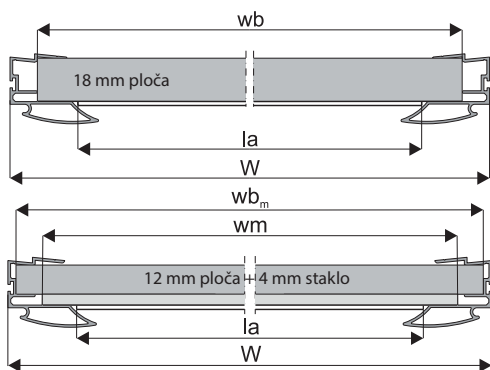

Dimenzije stakla

visina stakla - $hm = hb - 4 \text{ mm}$

širina stakla - $wm = wb_m - 20 \text{ mm}$

UPOZORENJE:

Prije ljepljenja ploče i stakla, prijanjajuće površine bi trebale biti čiste od prašine ili masnoća.

Is crtane linije prikazuju preporuku za pozicioniranje obostrano ljepljive trake

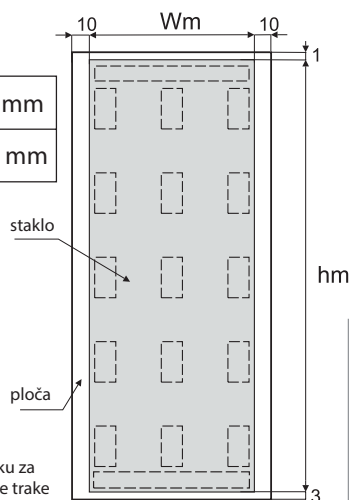

- ne koristiti ljepilo za pričvršćivanje profila ručke na ploču
- ručka se fiksira na ploču pomoću vijaka sa unutarnje strane vrata

Instalacija ručke i gornjih kotača na 18 mm ploču

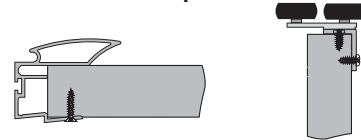

Instalacija ručke i gornjih kotača na 12 mm ploču s 4 mm staklom

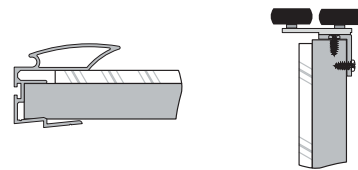

Instalacija L profila

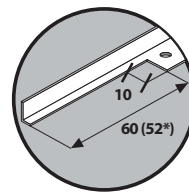
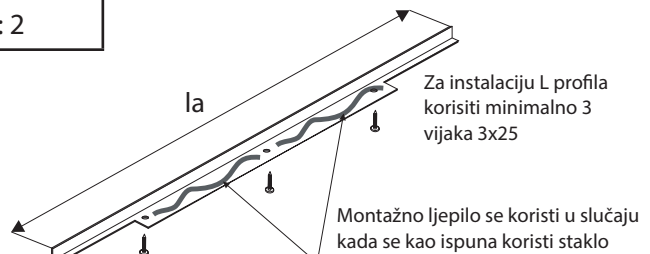
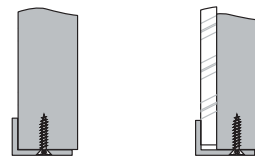

(*) mjere u slučaju da je ispuna 12 mm

UPOZORENJE!
 Profil ručke mora biti 2mm duži od ispune zbog ugradnje L-profila

UPOZORENJE!
 Uvijanje vratiju radi neprimjerene kvalitete ispune (ploče) nije predmet reklamacije. korištenje silikona ili ljepila te vlaga mogu utjecati na uvijanje ploča.

Ručka FAWORYT – ugradnja i mjere

Dimenzije otvora

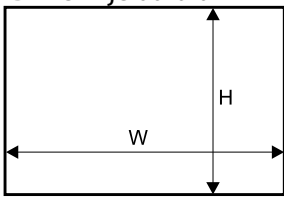

VISINA RUČKE = VISINA VRATA

visina vrata	- h	$h = H - 42 \text{ mm}$
visina vrata sa soft-close mehanizmom		$h = H - 42 \text{ mm}$
visina ploče	- hb	$hb = h - 2 \text{ mm}$
širina vrata	- w	$w = (W - 3 + Z) : N$
širina ploče 18 mm	- wb	$wb = w - 19 \text{ mm}$
širina ploče 12 mm	- wb_m	$wb_m = w - 7 \text{ mm}$
dužina L profila	- la	dužina L profila se određuje nakon konstrukcije vrata

broj vrata	- N	2	3	4	5
preklapanje	- Z	18 mm	36 mm	54 mm	72 mm

primjer - 4 vrata s 2 različita rasporeda

	$w = (W - 3 + 54) : 4$
	$w = (W - 2 + 15) : 2$

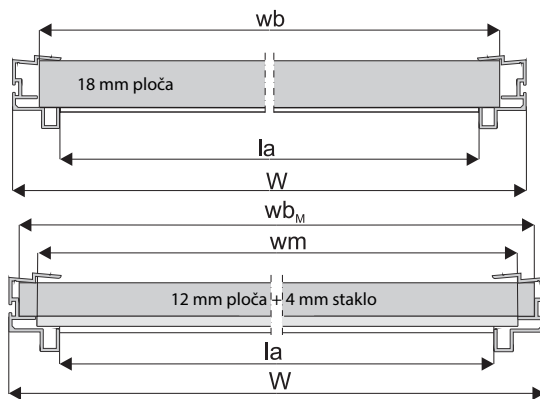

Dimenzije stakla

visina stakla - $hm = hb - 4 \text{ mm}$

širina stakla - $wm = wb_m - 16 \text{ mm}$

UPOZORENJE:

Prije ljepljenja ploče i stakla, prijanjajuće površine bi trebale biti čiste od prašine ili masnoća.

Is crtane linije prikazuju preporuku za pozicioniranje obostrano ljepljive trake

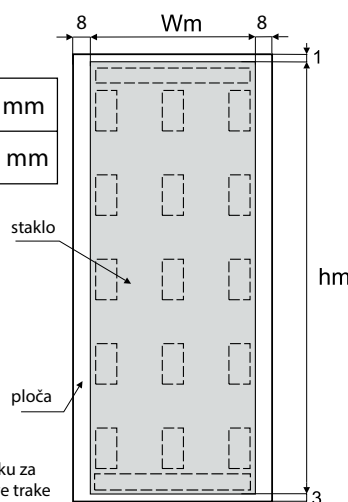

- ne koristiti ljepilo za pričvršćivanje profila ručke na ploču
- ručka se fiksira na ploču pomoću vijaka sa unutarnje strane vrata

Instalacija ručke i gornjih kotača na 18 mm ploču

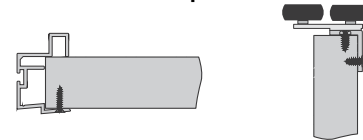

Instalacija ručke i gornjih kotača na 12 mm ploču s 4 mm staklom

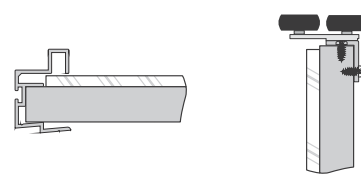

Instalacija L profila

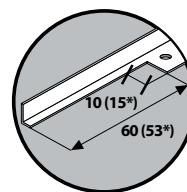
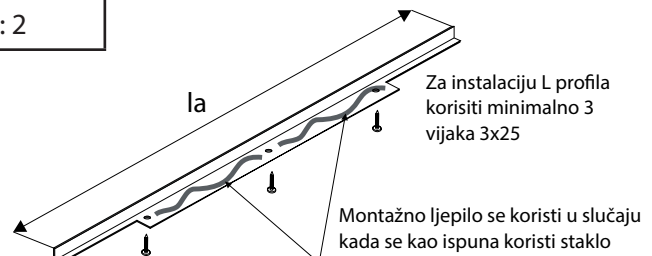
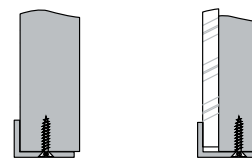

(*) mjere u slučaju da je ispuna 12 mm

UPOZORENJE!
 Profil ručke mora biti 2mm duži od ispune zbog ugradnje L-profila

UPOZORENJE!
 Uvijanje vratiju radi neprimjerene kvalitete ispune (ploče) nije predmet reklamacije. korištenje silikona ili ljepila te vlaga mogu utjecati na uvijanje ploča.

Ručka ROMA – ugradnja i mjere

Dimenzije otvora

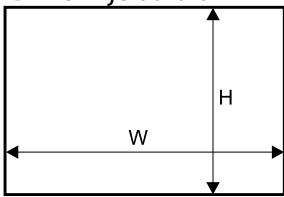



VISINA RUČKE = VISINA VRATA

visina vrata	- h	$h = H - 42 \text{ mm}$
visina vrata sa soft-close mehanizmom		$h = H - 42 \text{ mm}$
visina ploče	- hb	$hb = h - 2 \text{ mm}$
širina vrata	- w	$w = (W - 3 + Z) : N$
širina ploče	- wb	$wb = w - 3 \text{ mm}$
dužina L profila	- la	dužina L profila se određuje nakon konstrukcije vrata

broj vrata	- N	2	3	4	5
preklapanje	- Z	22 mm	44 mm	66 mm	88 mm

primjer - 4 vrata s 2 različita rasporeda

	$w = (W - 3 + 66) : 4$
	$w = (W - 2 + 19) : 2$

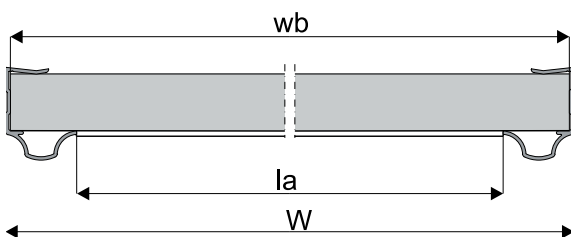

UPOZORENJE!

Uvijanje vratiju radi neprimjerene kvalitete ispune (ploče) nije predmet reklamacije. korištenje silikona ili ljepila te vlaga mogu utjecati na uvijanje ploča.

- ne koristiti ljepilo za pričvršćivanje profila ručke na ploču

Instalacija ručke i gornjih kotača na 18 mm ploču

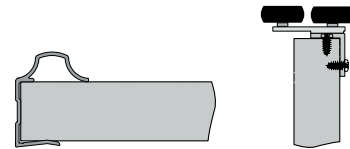

Instalacija L profila

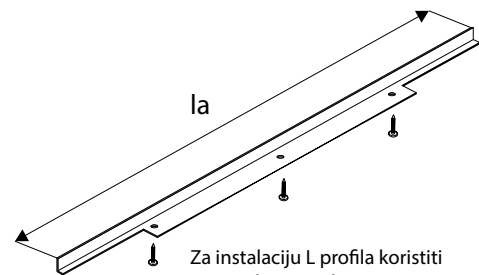

Za instalaciju L profila koristiti minimalno 3 vijaka 3x25.

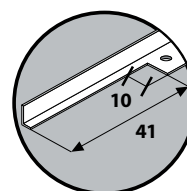

UPOZORENJE!

Profil ručke mora biti 2mm duži od ispune zbog ugradnje L-profila

Instrukcije za montažu - ručka TYTAN

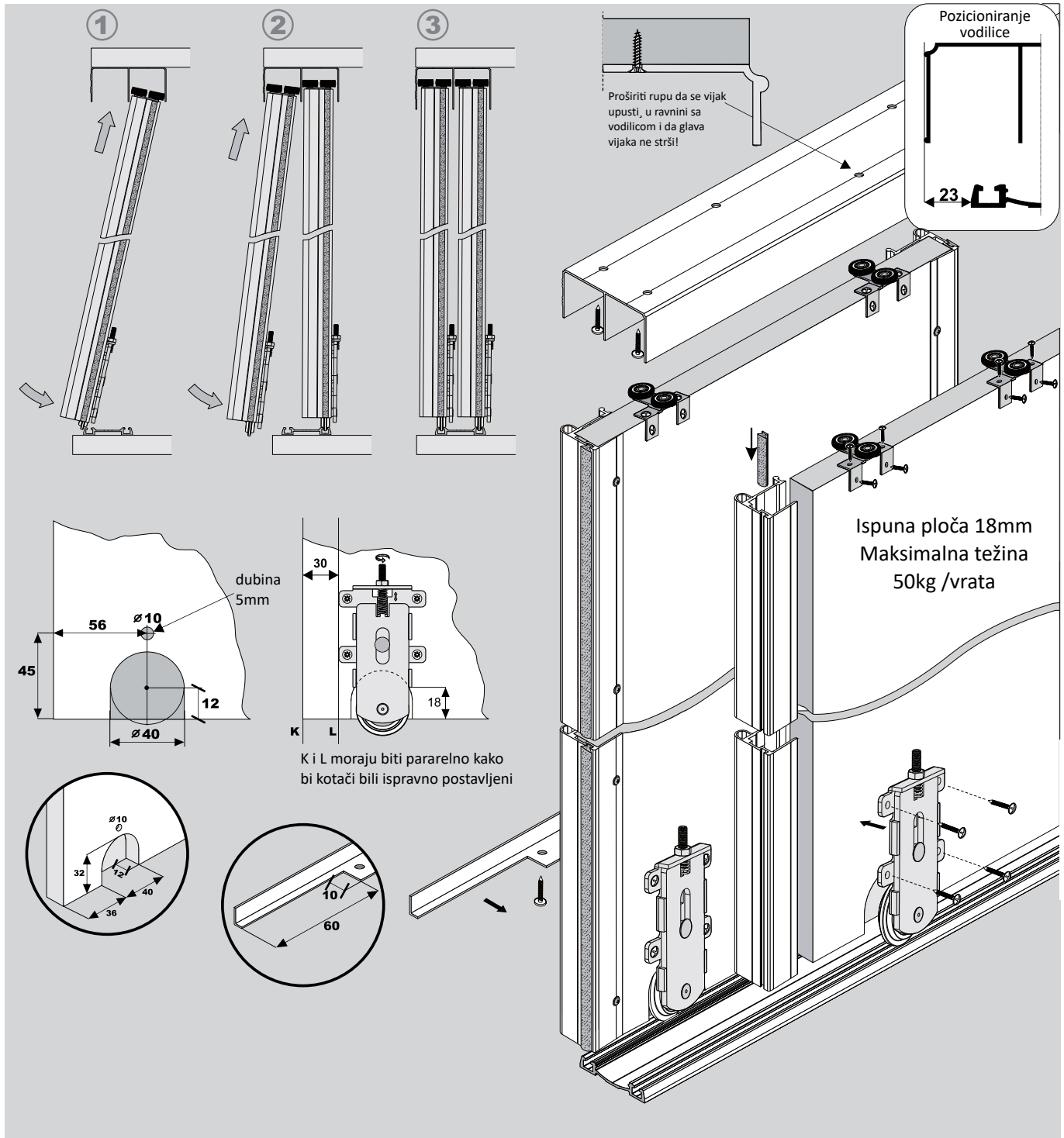

Gemini 18 – sistem za klizna vrata

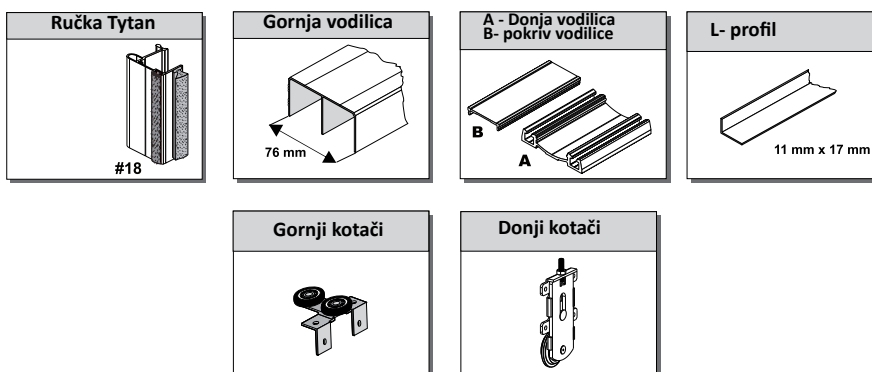

Ručka TYTAN – ugradnja i mjere

Dimenzije otvora

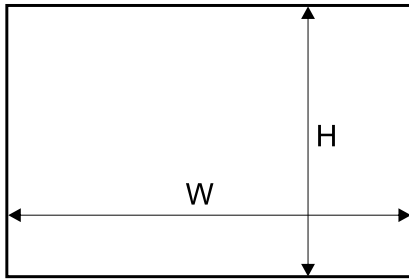



VISINA RUČKE = VISINA VRATA

Ispuna 18mm ploča

Visina vrata	- h	$h = H - 42 \text{ mm}$
Visina vrata sa soft-close mehanizmom		$h = H - 42 \text{ mm}$
Visina ploče	- hb	$hb = h - 2 \text{ mm}$
Širina vrata	- w	$w = (W - 3 \text{ mm} + Z) : N$
Širina ploče	- wb	$wb = w - 7 \text{ mm}$
Dužina L profila	- la	$la = w - 62 \text{ mm}$

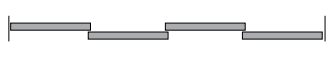
Broj vrata	- N	2	3	4	5
Preklapanje	- Z	31 mm	62 mm	93 mm	124 mm

primjer - 4 vrata s 2 različita rasporeda	
	$w = (W - 3 + 93) : 4$
	$w = (W : 2 + 28) : 2$

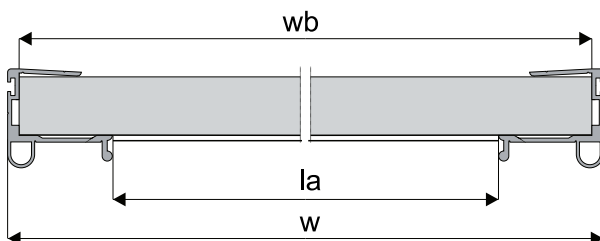

UPOZORENJE!

Profil ručke mora bit 2mm duži od ispune!

ne koristiti ljepilo za pričvršćivanje profila ručke na ploču

ručka se fiksira na ploču pomoću vijaka sa unutarnje strane vrata

instalacija ručke i gornjih kotača na ploču 18mm

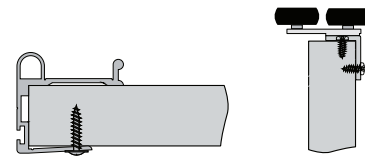

instalacija L profila

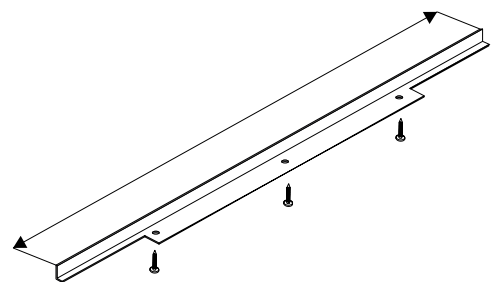

UPOZORENJE!

Uvijanje vratju radi neprimjerene kvalitete ispune (ploče) nije predmet reklamacije. Korištenje silikona ili ljepila te vlaga mogu utjecai na uvijanje ploča.

BW 18 – sistem za klizna vrata



Profilna ručka BW18-1

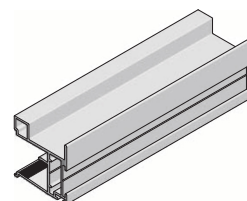
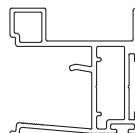

Ident	Naziv	MJ
THNONE18270ALU	RUČKICA BW18, 270 cm, ALU	KOM
THNONE18270B	RUČKICA BW18, 270 cm, alu - BIJELA	KOM
THNONE18270C	RUČKICA BW18, 270 cm, alu - CRNA	KOM

Vodilice BW18



Ident	Naziv	MJ
THDV405B	AL.PROFIL VOD.DONJA - 405 cm bijela	KOM
THDV405C	AL.PROFIL VOD.DONJA - 405 cm crna	KOM
THGV405B	AL.PROFIL VOD.GORNJA - 405 cm bijela	KOM
THGV405C	AL.PROFIL VOD.GORNJA - 405 cm crna	KOM

Kotači BW18



Ident	Naziv	MJ
THEVO18KD	Kotačić za Alu profil EVO - donji	KOM
THEVO18KG	Kotačić za Alu profil EVO - gornji	KOM
THGST	Stoper za gornje kotače	KOM
SVRSCET	SEVROLL četkica za ručku 14 x 4 mm uvlačna	TM

Horizontalni profili BW18

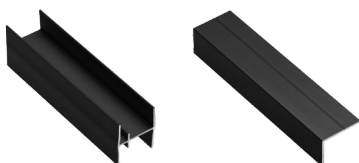

Ident	Naziv	MJ
THH3MB	AL.PROFIL HR 18/4mm - 300cm bijeli	KOM
THH3MC	AL.PROFIL HR 18/4mm - 300cm crni	KOM
THL3MB	AL.PROFIL L 18 mm - 300 cm bijeli	KOM
THL3MC	AL.PROFIL L 18 mm - 300 cm crni	KOM

Mjere za ugradnju BW18

DIMENZIJE OTVORA

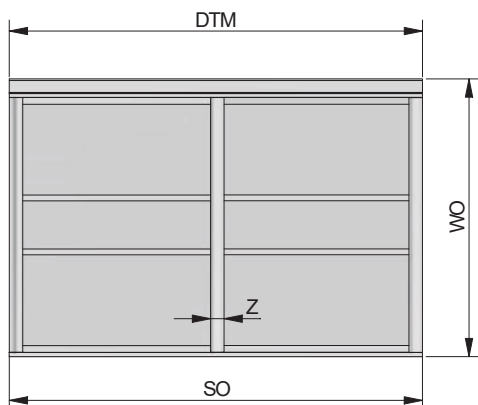

DIMENZIJE VRATA

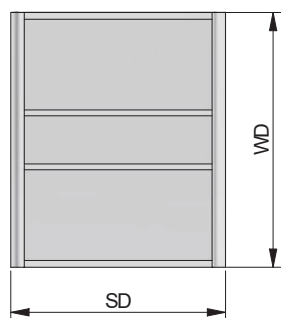

DIMENZIJE PROFILA I ISPUNA

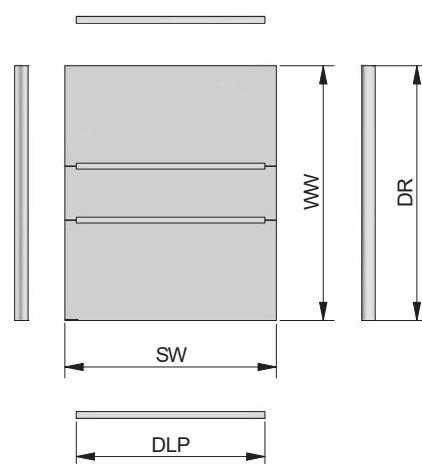

Dužina gornje i donje vodilice (SO) =	Dužina svjetlog otvora (DTM)	
Visina vrata (WD)=	Visina svjetlog otvora (WD) - 40mm	
Širina preklapanja (Z)=	29mm	
Širina vrata (SD) =	$(SO - 3 + k \times Z) / n$ *	K= broj preklopa, Z=29mm, n=broj vrata
Širina ispune (SW)=	SD-31mm	
Širina ispune staklo 4mm (SW4)=	SD-23mm	
Visina ispune (WW)=	WD	Ako se stavlja kutni L profil oduzima se 3mm
Širina horizontala (DLP)=	SD-55mm	
Dužina ručki (DR)=	WD	

*Ukoliko se ne stavlja brtvena četkica formula je $(SO + k \times Z) / n$

MJERA RUČKA BW18

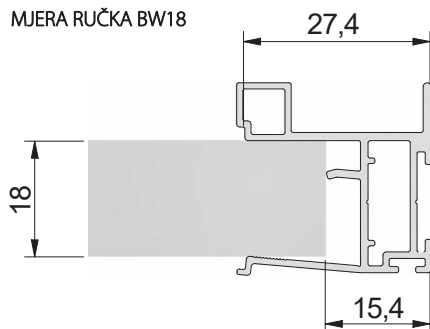

MJERA RUČKA BW18 - STAKLO ISPUNA 4mm

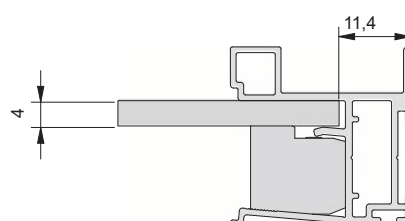

STOPERI

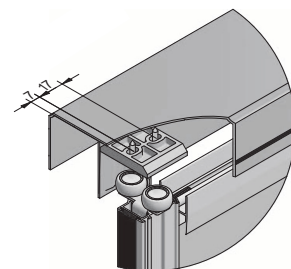

GLODANJE ZA KOTAČ

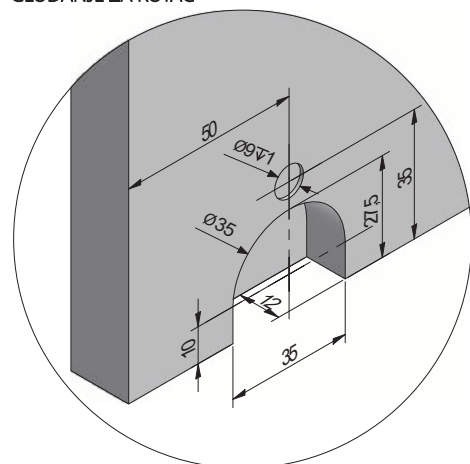

MJERA H PROFIL

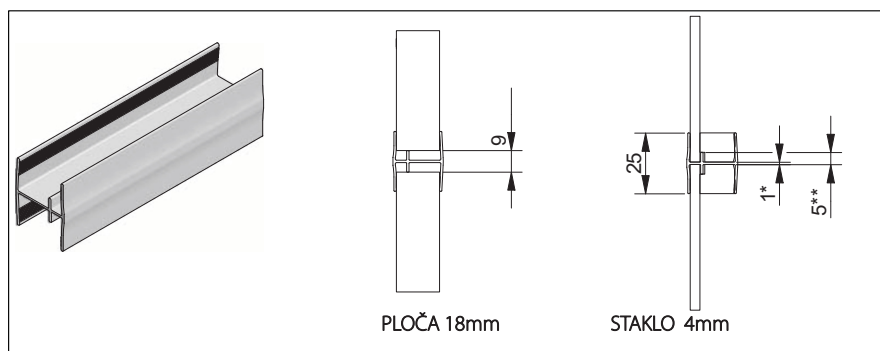

MJERA L PROFIL

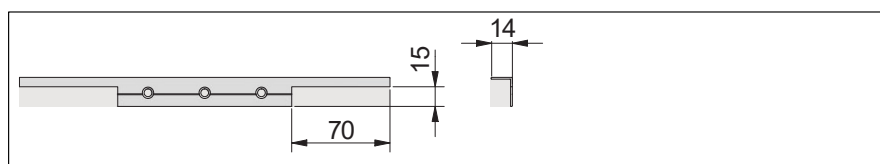

PRIKAZ KOTAČA na vodilici

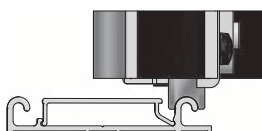

PREDNOSTI ZA KUPCE



Više od 32.000 artikala na zalihama



Partner industriji namještaja, distributerima i obrtnicima



Slanje proizvoda po cijelom svijetu



Naše skladište = vaše zalihe



Tehnička podrška



Više od 25 godina iskustva

OKOV ZA NAMJEŠTAJ



Nema najmanjih količina za narudžbu



širok izbor u različitim cjenovnim razredima



Metalna galanterija po narudžbi

 **BLAŽIĆ**

2019
HR